

CONTI® SYNCHRODRIVE

Polyurethane Synchronous Drive Belts



© Registered trademark of Continental



Index

3–8 CONTI® SYNCHRODRIVE Synchronous Drive Belts

- 4 Properties
- 5 Construction
- 6 Designation
- 6 Product range
- 8 Tolerances

9–16 Pulleys

- 10 Designation
- 11 Minimum number of teeth
- 12 Diameters
- 15 Tolerances
- 16 Clamps, dimensions and clamping lengths

17–34 Calculation of Synchronous Belt Drives

- 19 Glossary of symbols and terms
- 20 Drive calculation data
- 28 Example of design procedure steps: Lifting drive
- 31 Example of design procedure steps: Linear drive

34 Index

36–39 Service and Accessories

- 36 Mulco belt-pilot
- 37 Polyurethane timing belt welder
- 38 List of catalogues
- 39 Addresses

CONTI® SYNCHRODRIVE Synchronous Drive Belts

Properties / Construction / Designation / Product range / Tolerances



CONTI® SYNCHRODRIVE Synchronous Drive Belts

CONTI® SYNCHRODRIVE Belts for synchronous transmission of rotary and linear motion

CONTI® SYNCHRODRIVE belts are power transmission products made from a highly durable polyurethane elastomer incorporating a steel-cord tension member. They are manufactured precisely to length using a newly developed production technique.

CONTI® SYNCHRODRIVE belts can be used in the open-ended or endless form. In all cases, they ensure that rotary motion is transmitted uniformly and with angular precision. CONTI® SYNCHRODRIVE belts permit low-cost drive designs, even where difficult operating conditions have to be taken into account. Their properties provide a highly reliable, maintenance-free solution to even the most demanding drive problems.

CONTI® SYNCHRODRIVE belts are available in 10 tooth profiles and several standard widths, covering a host of different applications involving various loads and service conditions. They are ideal for drives with a large center distance, for synchronous conveyor systems and transport devices with sliding rails as well as for positioning and reversing drives in linear and control engineering. Modern production techniques and rigorous in-process quality controls guarantee products with maximum reliability and a consistently high standard of quality.

Properties

Precise synchronism due to positive engagement

The belt teeth mesh with those of the pulley in the same manner as the teeth on a gear. This positive drive principle provides synchronous operation and eliminates speed variation.

A variety of possible applications at low design cost

CONTI® SYNCHRODRIVE belts can be used as synchronous drive or transport belts in either the open-ended or endless version. For special applications, CONTI® SYNCHRODRIVE belts can have heavy-duty profiles welded to them for indexing and conveying applications. As open-ended drive components, CONTI® SYNCHRODRIVE belts are ideal for linear and control drives that have to transmit rotary motion with repeat accuracy and multiple positioning control.

Low loads on shafts and bearings

The tooth grip principle requires only low initial belt tensioning. Thus the load on shafts and bearings is kept to a minimum.

Compact drive design

High dynamic stability and flexibility allows the use of small pulley diameters, low center distances, and belt-back idlers. This enables a lightweight, low-cost drive setup with less space requirement.

No maintenance

CONTI® SYNCHRODRIVE belts are maintenance-free; no lubrication or retensioning is required. Constant belt tension is guaranteed by the use of a high-strength steel-cord tension member.

High efficiency

The superb flexural properties of the synchronous drive belt as well as the exact dimensional mating of the belt and pulley tooth contours permit drives with an efficiency of 98%.

CONTI® SYNCHRODRIVE belts are resistant to

- wear
- oil and grease
- petrol and benzene
- hydrolysis
- UV and ozone
- temperatures ranging from – 30 °C to 80 °C (for operational temperatures outside –10 °C to 50 °C please seek advice from your Mulco sales partner)
- can be bonded to thermoplastics

Belt versions

CONTI® SYNCHRODRIVE belts are supplied in the following versions:

- | | |
|---|--|
| <p>HF ▶ high flexibility version
all profiles except for 3 mm pitch
e.g. for drives with small pulley diameters.</p> <p>HP ▶ high power reinforced version
HTD and STD profiles, e.g. for heavy-duty control systems.</p> <p>HS ▶ high stiffness of tension member
HTD and STD profiles, e.g. for high-precision linear drives.</p> | <p>XHP ▶ extremely high power tensile-strength
HTD 14M profile, e.g. for lifting systems.</p> <p>PAZ ▶ with polyamide fabric facing on the teeth side
e.g. for sliding-rail transport systems.
Antistatic aPAZ version on request.</p> <p>PAR ▶ with polyamide fabric facing on the back of the belt e.g. for skid-queuing conveyors.
Antistatic aPAR version on request.</p> <p>V ▶ endless belt in HF version and lengths from 1000 mm, all profiles except for 3 mm pitch e.g. for rotary drives with large center distances.</p> |
|---|--|

Other special versions, e. g. aramid tension member, can be supplied on request.

Construction

Our synchronous drive belts are made up of:

- ▶ polyurethane teeth and back, color: black
- ▶ steel-cord tension member, with balanced right/left-handed cord twist

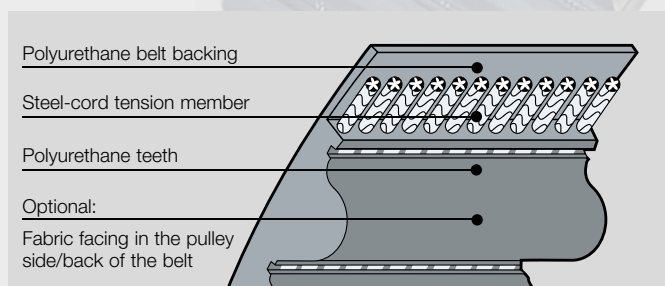

Polyurethane teeth and back

Belt teeth and back are made from a tough polyurethane elastomer with excellent adhesion to the tension member. The high wear resistance of the polyurethane ensures trouble-free drive performance and a long service life. These features are enhanced even more by the balanced layout of the tension cords.

Steel-cord tension member

Synchronous drive belts for positive drive systems must have a high resistance to elongation and a high tensile strength. Extra-strong steel tension cords, laid parallel to the belt edges, guarantee the belt's high loading capacity and accurate running properties.

CONTI® SYNCHRODRIVE Synchronous Drive Belts

Designation

CONTI® SYNCHRODRIVE synchronous drive belts are specified in accordance with defined standards for the different belt types showing the pitch length, tooth pitch and belt width, plus a code for the belt version, see page 5.

- Pitch length in m
 The pitch length of the belt is the overall circumference, or length measured at the neutral pitch line. The pitch length is located in the middle of the tension member.
- Tooth pitch in mm
 The tooth pitch is the linear distance between two adjacent teeth at the pitch line.
- Belt width in mm
 The belt width and width designation are identical.

Examples:
CONTI® SYNCHRODRIVE HTD drive belts
M 30-8M-50 HP

M	open-ended type
30	pitch length 30 m
8M	tooth pitch 8 mm , HTD profile
50	belt width 50 mm
HP	reinforced version

CONTI® SYNCHRODRIVE STD drive belts
V 2400-S 5M-30 HF

V	endless type
2400	belt length 2400 mm
S 5M	tooth pitch 5 mm, STD profile
30	belt width 30 mm
HF	flexible version

The number of teeth is a function of pitch length and pitch:

$$z = \frac{L_w}{t}$$

Product range

Profiles

CONTI® SYNCHRODRIVE synchronous drive belts are manufactured in 10 profile sizes. Dimensions of HTD and STD synchronous drive belts correspond to the specifications laid down in ISO/F DIS 13050 (draft version). Table 1 on page 7 gives a summary of the profile dimensions as well as other technical information for the belts we supply. Special pulleys must be used for linear drives with high precision requirements. More information about pulleys is given in section 2 on "Pulleys" which starts on page 10.

Lengths

CONTI® SYNCHRODRIVE synchronous drive belts are available in either the open-ended or endless version.

Widths

CONTI® SYNCHRODRIVE synchronous drive belts are supplied in several standard widths. Dimensions are given in Table 2 on page 7. Other widths are available on request.

Versions

CONTI® SYNCHRODRIVE synchronous drive belts made from polyurethane with steel cords aligned parallel to the belt edges are precision-made components for applications in drive and transportation engineering. Several versions are available to meet various operating requirements. More details are given on page 4 under "Properties".

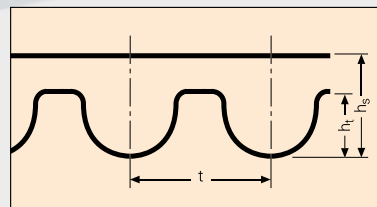
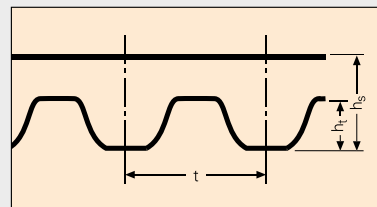

Fig. 1

Tooth profile
 HTD 3M, HTD 5M,
 HTD 8M, HTD 14M



Tooth profile
 STD S 5M, STD S 8M,
 STD S 3M on request

Table 1 Specifications								
Tooth profile		HTD				STD		
		3M	5M	8M	14 M	S 3M	S 5M	S 8M
Tooth pitch t	mm	3,00	5,00	8,00	14,00	3,00	5,00	8,00
Belt thickness h_s	mm	2,40	3,60	5,60	10,00	2,30	3,40	5,20
Tooth height h_t	mm	1,30	2,10	3,40	6,10	1,14	1,90	3,00
Weight m_{spez} per mm of belt width								
Type HF	10^{-3} kg/m		3,36	5,40	10,37		3,21	5,24
Type HP	10^{-3} kg/m	3,15	4,06	6,32	11,27	3,08	3,91	6,22
Type HS	10^{-3} kg/m			7,22	11,40		4,64	7,12
Type XHP	10^{-3} kg/m				14,00			
Standard lengths								
Type M L_w	m	30 or 60						

Table 2 Belt width – b in mm							
Tooth profile	HTD				STD		
	3M	5M	8M	14M	S 3M	S 5M	S 8M
	5	5			5	5	
	10	10	10		10	10	10
	15	15	15		15	15	15
			20				20
	25	25		25	25	25	
			30				30
				40			
	50	50	50	50/55	50	50	50
			85	85			85
			100	100			100
				115			
				120			
				150			

Other intermediate widths on request.

CONTI® SYNCHRODRIVE Synchronous Drive Belts

Tolerances

CONTI® SYNCHRODRIVE synchronous drive belts are precision-made products. Manufacturing involves reliable process techniques and maximum accuracy throughout all stages. Deviations in length, width and thickness are subject to extremely tight tolerances.

Table 3 Belt length tolerances	
Pitch length L_w mm	Length tolerance %
L_w	$\pm 0,1$

Table 4 Belt width tolerances								
Tooth profile		HTD				STD		
		3M	5M	8M	14 M	S 3M	S 5M	S 8M
Belt width b	up to 25 mm	$\pm 0,5$	$\pm 0,5$	$\pm 0,6$	$\pm 0,6$	$\pm 0,5$	$\pm 0,5$	$\pm 0,6$
	> 25-50 mm	$\pm 0,6$	$\pm 0,6$	$\pm 0,7$	$\pm 1,0$	$\pm 0,6$	$\pm 0,6$	$\pm 0,7$
	> 50 mm			$\pm 0,8$	$\pm 1,2$			$\pm 0,8$

Table 5 Belt thickness tolerances (Type M)								
Tooth profile		HTD				STD		
		3M	5M	8M	14 M	S 3M	S 5M	S 8M
Belt thickness h_s	mm	2,4	3,6	5,6	10	2,3	3,4	5,2
Thickness tolerance	mm	$\pm 0,25$	$\pm 0,25$	$\pm 0,4$	$\pm 0,6$	$\pm 0,25$	$\pm 0,25$	$\pm 0,4$

Pulleys

Designation / Minimum number of teeth / Diameters / Tolerances / Clamping length

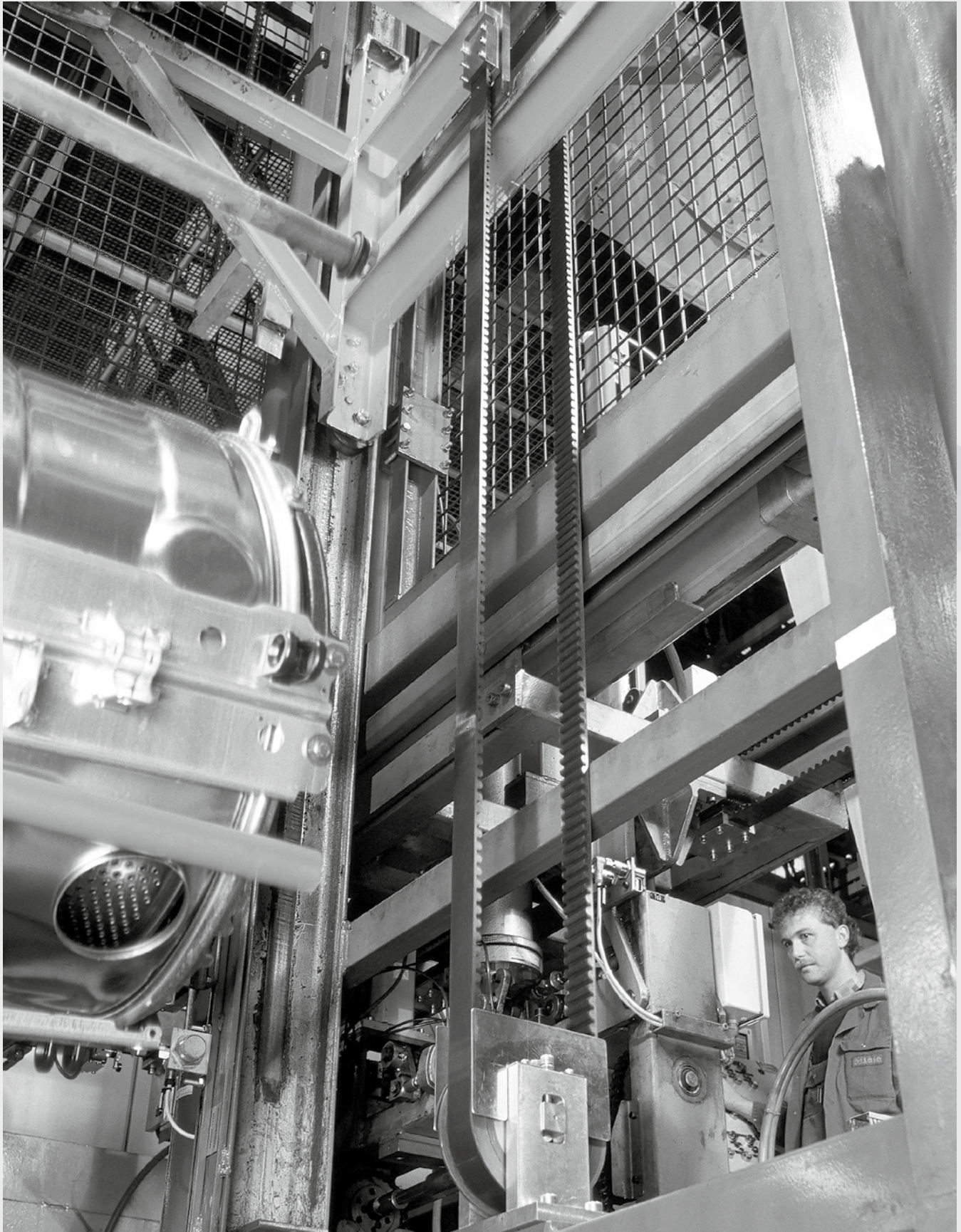

Pulleys

Pulleys

Precise belt/pulley conformance is vital to ensure accurate power transmission as well as smooth operation and a long service life for synchronous belt drives.

ContiTech engineers have modified pulley tooth-gap profiles so that they conform ideally to the respective belt profiles.

Use of these optimized pulleys is recommended especially for CONTI® SYNCHRODRIVE HTD belts.

Pulleys with optimized profiles are obtainable from your Mulco sales partner.

Linear drives with demanding positioning requirements need pulleys with minimized gap clearance. If you are planning a special drive design, please consult our application engineers for advice.

Designation

Pulleys for CONTI® SYNCHRODRIVE belt drives are identified in accordance with the standards defined for the various belt types by their number of teeth, tooth pitch and pulley width, as well as a code denoting the type of pulley.

- P
General designation for toothed pulleys.
- Number of teeth
The pulley's number of teeth is calculated from the pitch circumference and the pitch:

$$z = \frac{U_w}{t} = \frac{\pi \cdot d_w}{t}$$

- Tooth pitch in mm
The tooth pitch of the pulley is the distance between two reference points on adjacent teeth at the circumference of the pitch diameter. The pitch diameter is larger than the outside diameter of the pulley by double the thickness at which the pitch line of belt rides above the pulley.

- Pulley width in mm
The width designation defines the exact width of the corresponding synchronous drive belt, and not that of the pulley.
- Flanged pulley data
F stands for pulleys that are flanged on both sides. Flanged pulleys prevent the belt from riding off. At least one pulley with two flanges must be used and generally, for economy, the smaller pulley of a drive is the flanged pulley. It is also possible to provide each pulley with one flange on alternate sides.

Examples:

HTD Pulley – P 36 – 8M – 40

P	Designation for toothed pulley
36	36 teeth
8M	8 mm tooth pitch, HTD profile
40	Pulley designation for a 40 mm wide synchronous drive belt

STD Pulley – P 48 – S 5M – 30

P	Designation for toothed pulley
48	48 teeth
S 5M	5mm tooth pitch, STD profile
30	Pulley designation for a 30 mm wide synchronous drive belt

Minimum number of teeth

Drives fitted with CONTI® SYNCHRODRIVE synchronous drive belts should have pulleys that meet the specified minimum number of teeth. Table 6 shows the minimum number of teeth z_{\min} and the minimum pitch diameter $d_{w \min}$ for pulleys as well as the minimum diameter d_{\min} for inside and outside idlers that are to be considered when designing a drive. Inside idlers should be toothed pulleys.

Table 6 Minimum number of teeth / - z_{\min}										
Tooth profile				HTD				STD		
				3M	5M	8M	14M	S 3M	S 5M	S 8M
Minimum number of teeth z_{\min}										
Type	HF				12	16	18		12	16
	HP			20	16	20	26	20	16	20
	HS					28	30		24	28
	XHP						34			
Minimum pitch $\varnothing d_{w \min}$										
Type	HF		mm		19,10	40,74	80,21		19,10	40,74
	HP		mm	19,10	25,46	50,93	115,86	19,10	25,46	50,93
	HS		mm			71,30	133,69		38,20	71,30
	XHP		mm				151,52			
Minimum \varnothing of idler d_{\min}										
Type	HF	inside	mm		19,10	40,74	80,21		19,10	40,74
		outside	mm		30,00	60,00	120,00		30,00	60,00
	HP	inside	mm	19,10	25,46	50,93	115,86	19,10	25,46	50,93
		outside	mm	30,00	50,00	100,00	160,00	30,00	50,00	100,00
	HS	inside	mm			71,30	133,69		44,56	71,30
		outside	mm			120,00	180,00		80,00	120,00
	XHP	inside	mm				151,52			
		outside	mm				200,00			

Minimum diameter Belt version V with omega pulley configuration: please call for technical support.

Pulleys

Diameters

Number of teeth, pitch and outside diameter of pulleys for drives fitted with CONTI® SYNCHRODRIVE belts are contained in Tables 7 to 13 (pages 12 to 15).

Table 7 Pulleys for CONTI® SYNCHRODRIVE HTD synchronous drive belts 3 mm tooth pitch, 3M profile (measurement in mm)											
Number of teeth z	Pitch diameter d _w	Outside diameter d _a	Number of Teeth z	Pitch diameter d _w	Outside diameter d _a	Number of Teeth z	Pitch diameter d _w	Outside diameter d _a	Number of teeth z	Pitch diameter d _w	Outside diameter d _a
20	19,10	18,34	35	33,42	32,66	50	47,75	46,99	65	62,07	61,31
21	20,05	19,29	36	34,38	33,62	51	48,70	47,94	66	63,03	62,27
22	21,01	20,25	37	35,33	34,57	52	49,66	48,90	67	63,98	63,22
23	21,96	21,20	38	36,29	35,53	53	50,61	49,85	68	64,94	64,18
24	22,92	22,16	39	37,24	36,48	54	51,57	50,81	69	65,89	65,13
25	23,87	23,11	40	38,20	37,44	55	52,52	51,75	70	66,85	66,09
26	24,83	24,07	41	39,15	38,39	56	53,48	52,72	71	67,80	67,04
27	25,78	25,02	42	40,11	39,35	57	54,43	53,67	72	68,75	67,99
28	26,74	25,98	43	41,06	40,30	58	55,39	54,63			
29	27,69	26,93	44	42,02	41,26	59	56,34	55,58			
30	28,65	27,89	45	42,97	42,21	60	57,30	56,54			
31	29,60	28,84	46	43,93	43,17	61	58,25	57,49			
32	30,56	29,80	47	44,88	44,12	62	59,21	58,45			
33	31,51	30,75	48	45,84	45,08	63	60,16	59,40			
34	32,47	31,71	49	46,79	46,03	64	61,12	60,36			

Table 8 Pulleys for CONTI® SYNCHRODRIVE HTD synchronous drive belts 5 mm tooth pitch, 5M profile (measurement in mm)											
Number of teeth z	Pitch diameter d _w	Outside diameter d _a	Number of teeth z	Pitch diameter d _w	Outside diameter d _a	Number of teeth z	Pitch diameter d _w	Outside diameter d _a	Number of teeth z	Pitch diameter d _w	Outside diameter d _a
12	19,10	17,96	28	44,56	43,42	44	70,03	68,89	60	95,49	94,35
13	20,69	19,55	29	46,15	45,01	45	71,62	70,48	61	97,08	95,94
14	22,28	21,14	30	47,75	46,61	46	73,21	72,07	62	98,68	97,54
15	23,87	22,73	31	49,34	48,20	47	74,80	73,66	63	100,27	99,13
16	25,46	24,32	32	50,93	49,79	48	76,39	75,25	64	101,86	100,72
17	27,06	25,92	33	52,52	51,38	49	77,99	76,85	65	103,45	102,31
18	28,65	27,51	34	54,11	52,97	50	79,58	78,44	66	105,04	103,90
19	30,24	29,10	35	55,70	54,56	51	81,17	80,03	67	106,63	105,49
20	31,83	30,69	36	57,30	56,16	52	82,76	81,62	68	108,23	107,09
21	33,42	32,28	37	58,89	57,75	53	84,35	83,21	69	109,82	108,68
22	35,01	33,87	38	60,48	59,34	54	85,94	84,80	70	111,41	110,27
23	36,61	35,47	39	62,07	60,93	55	87,54	86,40	71	113,00	111,86
24	38,20	37,06	40	63,66	62,52	56	89,13	87,99	72	114,59	113,45
25	39,79	38,65	41	65,25	64,11	57	90,72	89,58			
26	41,38	40,24	42	66,85	65,71	58	92,31	91,17			
27	42,97	41,83	43	68,44	67,30	59	93,90	92,76			

Table 9 Pulleys for CONTI® SYNCHRODRIVE HTD synchronous drive belts 8 mm tooth pitch, 8M profile (measurement in mm)											
Number of teeth z	Pitch diameter d _w	Outside diameter d _a	Number of teeth z	Pitch diameter d _w	Outside diameter d _a	Number of teeth z	Pitch diameter d _w	Outside diameter d _a	Number of teeth z	Pitch diameter d _w	Outside diameter d _a
16	40,74	39,37	31	78,94	77,57	46	117,14	115,77	61	155,34	153,97
17	43,29	41,92	32	81,49	80,12	47	119,68	118,31	62	157,88	156,51
18	45,84	44,47	33	84,03	82,66	48	122,23	120,86	63	160,43	159,06
19	48,38	47,01	34	86,58	85,21	49	124,78	123,41	64	162,97	161,60
20	50,93	49,56	35	89,13	87,76	50	127,32	125,95	65	165,52	164,15
21	53,48	52,11	36	91,67	90,30	51	129,87	128,50	66	168,07	166,70
22	56,02	54,65	37	94,22	92,85	52	132,42	131,05	67	170,61	169,24
23	58,57	57,20	38	96,77	95,40	53	134,96	133,59	68	173,16	171,79
24	61,12	59,75	39	99,31	97,94	54	137,51	136,14	69	175,71	174,34
25	63,66	62,29	40	101,86	100,49	55	140,06	138,69	70	178,25	176,88
26	66,21	64,84	41	104,41	103,04	56	142,60	141,23	71	180,80	179,43
27	68,75	67,38	42	106,95	105,58	57	145,15	143,78	72	183,35	181,98
28	71,30	69,93	43	109,50	108,13	58	147,70	146,33			
29	73,85	72,48	44	112,05	110,68	59	150,24	148,87			
30	76,39	75,02	45	114,59	113,22	60	152,79	151,42			

Table 10 Pulleys for CONTI® SYNCHRODRIVE HTD synchronous drive belts 14 mm tooth pitch, 14M profile (measurement in mm)											
Number of teeth z	Pitch diameter d _w	Outside diameter d _a	Number of teeth z	Pitch diameter d _w	Outside diameter d _a	Number of teeth z	Pitch diameter d _w	Outside diameter d _a	Number of teeth z	Pitch diameter d _w	Outside diameter d _a
18	80,21	77,41	33	147,06	144,26	48	213,90	211,10	63	280,75	277,95
19	84,67	81,87	34	151,52	148,71	49	218,36	215,56	64	285,20	282,40
20	89,13	86,33	35	155,97	153,17	50	222,82	220,02	65	289,66	286,86
21	93,58	90,78	36	160,43	157,63	51	227,27	224,47	66	294,12	291,32
22	98,04	95,24	37	164,88	162,08	52	231,73	228,93	67	298,57	295,77
23	102,50	99,70	38	169,34	166,54	53	236,18	233,38	68	303,03	300,23
24	106,95	104,15	39	173,80	171,00	54	240,64	237,84	69	307,48	304,68
25	111,41	108,61	40	178,25	175,45	55	245,10	242,30	70	311,94	309,14
26	115,86	113,06	41	182,71	179,91	56	249,55	246,75	71	316,40	313,60
27	120,32	117,52	42	187,16	184,36	57	254,01	251,21	72	320,85	318,05
28	124,78	121,98	43	191,62	188,82	58	258,47	255,67			
29	129,23	126,43	44	196,08	193,28	59	262,92	260,12			
30	133,69	130,89	45	200,53	197,73	60	267,38	264,58			
31	138,15	135,35	46	204,99	202,19	61	271,83	269,03			
32	142,50	139,80	47	209,45	206,65	62	276,29	273,49			

Pulleys

Diameter

Table 11 Pulleys for CONTI® SYNCHRODRIVE STD synchronous drive belts 3 mm tooth pitch, S 3M profile (measurement in mm)											
Number of teeth z	Pitch diameter d _w	Outside diameter d _a	Number of teeth z	Pitch diameter d _w	Outside diameter d _a	Number of teeth z	Pitch diameter d _w	Outside diameter d _a	Number of teeth z	Pitch diameter d _w	Outside diameter d _a
20	19,10	18,34	35	33,42	32,66	50	47,75	46,99	65	62,07	61,31
21	20,05	19,29	36	34,38	33,62	51	48,70	47,94	66	63,03	62,27
22	21,01	20,25	37	35,33	34,57	52	49,66	48,90	67	63,98	63,22
23	21,96	21,20	38	36,29	35,53	53	50,61	49,85	68	64,94	64,18
24	22,92	22,16	39	37,24	36,48	54	51,57	50,81	69	65,89	65,13
25	23,87	23,11	40	38,20	37,44	55	52,52	51,75	70	66,85	66,09
26	24,83	24,07	41	39,15	38,39	56	53,48	52,72	71	67,80	67,04
27	25,78	25,02	42	40,11	39,35	57	54,43	53,67	72	68,75	67,99
28	26,74	25,98	43	41,06	40,30	58	55,39	54,63			
29	27,69	26,93	44	42,02	41,26	59	56,34	55,58			
30	28,65	27,89	45	42,97	42,21	60	57,30	56,54			
31	29,60	28,84	46	43,93	43,17	61	58,25	57,49			
32	30,56	29,80	47	44,88	44,12	62	59,21	58,45			
33	31,51	30,75	48	45,84	45,08	63	60,16	59,40			
34	32,47	31,71	49	46,79	46,03	64	61,12	60,36			

Table 12 Pulleys for CONTI® SYNCHRODRIVE STD synchronous drive belts 5 mm tooth pitch, S 5M profile (measurement in mm)											
Number of teeth z	Pitch diameter d _w	Outside diameter d _a	Number of teeth z	Pitch diameter d _w	Outside diameter d _a	Number of teeth z	Pitch diameter d _w	Outside diameter d _a	Number of teeth z	Pitch diameter d _w	Outside diameter d _a
12	19,10	18,14	28	44,56	43,60	44	70,03	69,07	60	95,49	94,53
13	20,69	19,73	29	46,15	45,19	45	71,62	70,66	61	97,08	96,12
14	22,28	21,32	30	47,75	46,79	46	73,21	72,25	62	98,68	97,72
15	23,87	22,91	31	49,34	48,38	47	74,80	73,84	63	100,27	99,31
16	25,46	24,50	32	50,93	49,97	48	76,39	75,43	64	101,86	100,90
17	27,06	26,10	33	52,52	51,56	49	77,99	77,03	65	103,45	102,49
18	28,65	27,69	34	54,11	53,15	50	79,58	78,62	66	105,04	104,08
19	30,24	29,28	35	55,70	54,74	51	81,17	80,21	67	106,63	105,67
20	31,83	30,87	36	57,30	56,34	52	82,76	81,80	68	108,23	107,27
21	33,42	32,46	37	58,89	57,93	53	84,35	83,39	69	109,82	108,86
22	35,01	34,05	38	60,48	59,52	54	85,94	84,98	70	111,41	110,45
23	36,61	35,65	39	62,07	61,11	55	87,54	86,58	71	113,00	112,04
24	38,20	37,24	40	63,66	62,70	56	89,13	88,17	72	114,59	113,63
25	39,79	38,83	41	65,25	64,29	57	90,72	89,76			
26	41,38	40,42	42	66,85	65,89	58	92,31	91,35			
27	42,97	42,01	43	68,44	67,48	59	93,90	92,94			

**Table 13 Pulleys for CONTI® SYNCHRODRIVE STD synchronous drive belts
8 mm tooth pitch, S 8M profile (measurement in mm)**

Number of teeth z	Pitch diameter d_w	Outside diameter d_a	Number of teeth z	Pitch diameter d_w	Outside diameter d_a	Number of teeth z	Pitch diameter d_w	Outside diameter d_a	Number of teeth z	Pitch diameter d_w	Outside diameter d_a
16	40,74	39,37	31	78,94	77,57	46	117,14	115,77	61	155,34	153,97
17	43,29	41,92	32	81,49	80,12	47	119,68	118,31	62	157,88	156,51
18	45,84	44,47	33	84,03	82,66	48	122,23	120,86	63	160,43	159,06
19	48,38	47,01	34	86,58	85,21	49	124,78	123,41	64	162,97	161,60
20	50,93	49,56	35	89,13	87,76	50	127,32	125,95	65	165,52	164,15
21	53,48	52,11	36	91,67	90,30	51	129,87	128,50	66	168,07	166,70
22	56,02	54,65	37	94,22	92,85	52	132,42	131,05	67	170,61	169,24
23	58,57	57,20	38	96,77	95,40	53	134,96	133,59	68	173,16	171,79
24	61,12	59,75	39	99,31	97,94	54	137,51	136,14	69	175,71	174,34
25	63,66	62,29	40	101,86	100,49	55	140,06	138,69	70	178,25	176,88
26	66,21	64,84	41	104,41	103,04	56	142,60	141,23	71	180,80	179,43
27	68,75	67,38	42	106,95	105,58	57	145,15	143,78	72	183,35	181,98
28	71,30	69,93	43	109,50	108,13	58	147,70	146,33			
29	73,85	72,48	44	112,05	110,68	59	150,24	148,87			
30	76,39	75,02	45	114,59	113,22	60	152,79	151,42			

Tolerances

Table 14 Outside diameter tolerances

Outside diameter d_a mm	Tolerance mm
≤ 25	+ 0,05 0
> 25 - 50	+ 0,08 0
> 50 - 100	+ 0,10 0
> 100 - 175	+ 0,13 0
> 175 - 300	+ 0,15 0
> 300 - 500	+ 0,18 0
> 500	+ 0,20 0

Table 15 Axial runout tolerances

Outside diameter d_a mm	Tolerance mm
≤ 100	0,1
> 100 - 250	0,001 per mm outside diameter
> 250	0,25 + 0,0005 per mm outside diameter

Table 16 Radial runout tolerances

Outside diameter d_a mm	Tolerance mm
≤ 200	0,13
> 200	0,13 + 0,0005 per mm outside diameter

Parallelism

Parallelism between the bore and teeth may not exceed the maximum deviation of 1 μm per millimetre of pulley width.

Draft

The maximum allowable draft is 1 μm per millimetre of face width, but it must not exceed the permissible diameter tolerance.

Pulleys

Clamp plates

CONTI® SYNCHRODRIVE synchronous drive belts that are used as opened power transmission components must be clamped with a positive fit at their ends. Clamp plates must have the corresponding tooth profile. The clamping screws should be positioned on both sides of the belt, and tightened in a uniform fashion.

Fig. 2 shows the type of clamp plate used. Dimensions for the standard type are given in Table 17.

Clamp plates for CONTI® SYNCHRODRIVE belt drives are available from your Mulco sales partner.

Fig. 2

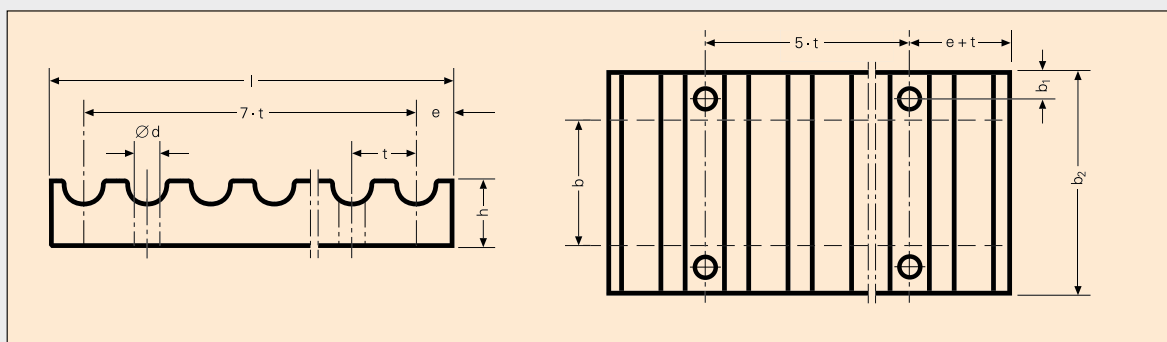

Clamp plate layout principle

Tooth profile	HTD				STD		
	3M	5M	8M	14M	S 3M	S 5M	S 8M
t		5,0	8,0	14,0		5,0	8,0
l		41,4	66,0	116,0		41,4	66,0
e		3,2	5,0	9,0		3,2	5,0
h		8,0	15,0	22,0		8,0	15,0
d		5,5	9,0	11,0		5,5	9,0
b ₁		6,0	8,0	10,0		6,0	8,0
b ₂ for synchronous drive belt width b mm	10,00		28,0				28,0
	15,00		34,0			34,0	40,0
	20,00			45,0			45,0
	25,00		44,0			44,0	
	30,00			55,0			55,0
	40,00				71,0		
	50,00			75,0			75,0
	55,00				86,0		
	85,00			110,0	116,0		110,0
	100,00				131,0		
	115,00				146,0		
	120,00				151,0		
150,00				181,0			

Clamp plates for STD S 3M and HTD 3M are available on request.

Calculation of synchronous belt drives

Glossery of symbols and terms, Drive calculation data,
Examples of design procedure steps: Lifting drive, Linear drive

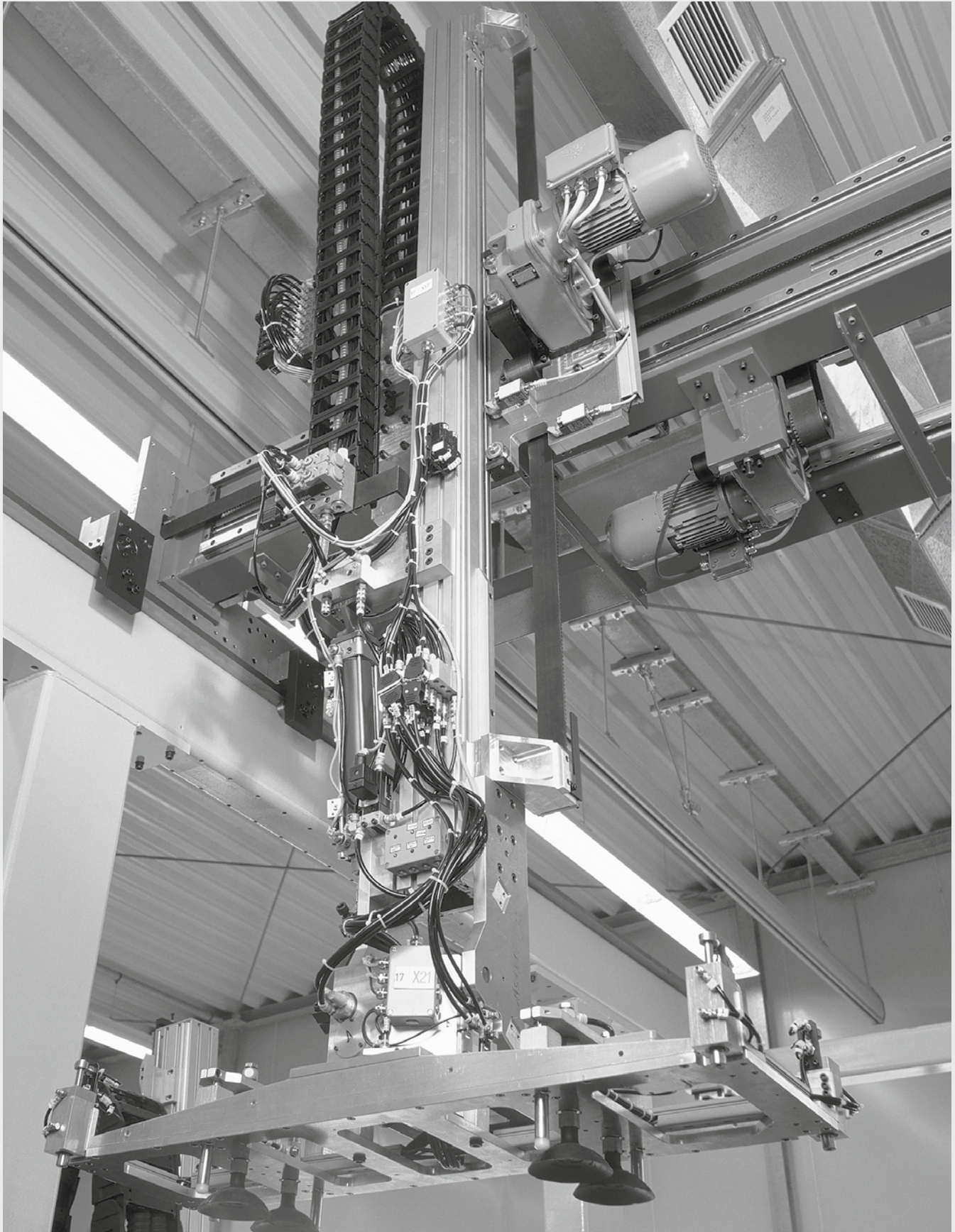

Calculation of synchronous belt drives

Calculation of synchronous belt drives

Calculations are based on drives fitted with CONTI® SYNCHRODRIVE synchronous drive belts. Drive design data are given in the following diagrams and tables. As so many factors influence belt performance, it is suggested that designers of complicated drives consult your Mulco sales Partner.

Fig. 3

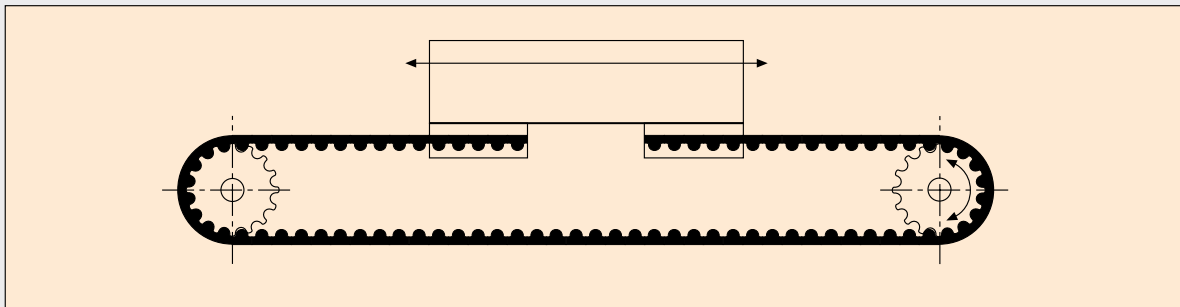

Synchronous belt linear drive with 2 pulleys and no deflection

Fig. 4

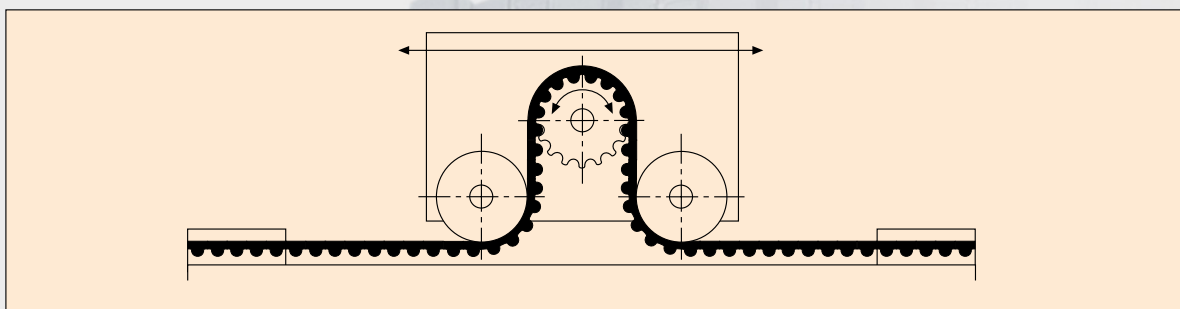

Synchronous belt linear drive with 1 pulley and deflection idlers

Calculation of synchronous belt drives

Glossary of symbols, units and terms

Symbol	Unit	Definition	Symbol	Unit	Definition
a	mm	centre distance	m_{ges}	kg	total weight
Δa	mm	take up allowance	m_R	kg	weight of belt
a_b	m/s^2	acceleration	m_S	kg	weight of carriage
a_v	m/s^2	braking deceleration	m_{Sch}	kg	weight of pulley
b	mm	belt width	$m_{Sch, red}$	kg	reduced weight of pulley
b_{err}	mm	calculated belt width	m_{spez}	kg/m	specific gravity of belt per m of length and mm of width
c_{spez}	N/mm	specific spring constant per mm of belt length and mm of width	m_U	kg	weight of deflection idler
c_0		overall service factor	$m_{U, red}$	kg	reduced weight of deflection idler
c_1		teeth in mesh factor	M	N/m	torque
$c_{1, max}$		maximum value for teeth in mesh factor	n	min^{-1}	pulley speed
c_2		load factor	n_1	min^{-1}	speed of driver pulley
c_3		acceleration factor	n_2	min^{-1}	speed of driven pulley
d	mm	pulley/idler diameter	P	kW	power
d_a	mm	outside diameter of pulley	s_b	m	acceleration distance
d_F	mm	design-specific finished bore	s_c	m	travel at v_{const}
d_{min}	mm	minimum diameter of idler	s_{ges}	m	total travel
d_w	mm	pitch diameter of pulley	s_v	m	braking distance
d_{w1}	mm	pitch diameter of driver pulley	t	mm	pitch
d_{w2}	mm	pitch diameter of driven pulley	t_c	s	travel time at v_{const}
f	Hz	natural frequency	U_w	mm	pitch circumference of pulley
F_R	N	friction force	v	m/s	belt speed
F_T	N	static belt tension	z		number of teeth on the pulley
$F_{T, max}$	N	maximum belt tension dynamic	z_e		number of meshing teeth
F_u	N	effective pull	z_g		number of teeth on the large pulley
$F_{u, max}$	N	maximum effective pull	z_k		number of teeth on the small pulley
$F_{u, spez}$	N	specific load on tooth flank	z_{min}		minimum number of teeth
F_v	N	belt installation tension	z_1		number of teeth on the driver pulley
F_{zul}	N	allowable load on tension member	z_2		number of teeth on the driven pulley
g	$9,81 m/s^2$	gravitational acceleration	β	$^\circ$ (degrees)	arc of contact around the small pulley
i		transmission ratio	μ		coefficient of friction
L_f	m	free span length for vibration excitation			
L_w	mm	pitch length of belt			
$L_{w, max}$	mm	maximum pitch length of belt			

Calculation of synchronous belt drives

Drive calculation data

The following pages contain all the data, formulae and tables needed when designing a new drive fitted with a CONTI® SYNCHRODRIVE synchronous drive belt. Tables for values which can easily be calculated using the formulae provided have been omitted.

The torques and effective pulls to be transmitted do not require any safety factors providing the maximum values are observed and the load is uniform. Corresponding factors must be applied in the event of fluctuating and alternating loads as well as with accelerating or braking processes.

Overall service factor c_0

The overall service factor c_0 takes into consideration the loads occurring under special operating conditions, and is the sum of load factor c_2 and acceleration factor c_3 .

$$c_0 = c_2 + c_3$$

Teeth in mesh factor c_1

The teeth in mesh factor c_1 considers the number of teeth z_e of the small pulley z_k meshing with the teeth of the synchronous drive belt.

$$z_e = z_k \cdot \frac{\beta}{360}$$

Calculation of the arc of contact β is explained on page 21. The value for teeth in mesh factor c_1 corresponds to the number of teeth in mesh z_e .

The following maximum values apply:

$$c_{1 \max} = 12 \text{ for CONTI® SYNCHRODRIVE synchronous drive belts, type M}$$

$$c_{2 \max} = 6 \text{ for CONTI® SYNCHRODRIVE synchronous drive belts, type V}$$

The minimum numbers of teeth z_{\min} for pulleys that are to be taken into consideration when designing a drive are contained in Table 6 on page 11.

Load factor c_2

Load factor c_2 is used to compensate for operating conditions. The factors given below are indicative values only.

Table 18 Load factor c_2	
Operation conditions	Load factor c_2
Steady load	1,0
Fluctuating load low	1,4
Fluctuating load average	1,7
Fluctuating load high	2,0

Acceleration factor c_3

The acceleration factor c_3 is applied if the step-up transmission ratio is > 1.24 .

Table 19 Acceleration factor c_3	
Transmission ratio $\frac{1}{i}$	Acceleration factor c_3
1,00 - 1,24	
1,25 - 1,74	0,1
1,75 - 2,49	0,2
2,50 - 3,49	0,3
$\geq 3,50$	0,4

Transmission ratio i

Transmission ratio i is obtained from the ratio of pulley speeds n_1 and n_2 or the number of teeth z_2 and z_1 or the pitch diameters of pulleys d_{w2} and d_{w1} .

$$i = \frac{n_1}{n_2} = \frac{z_2}{z_1} = \frac{d_{w2}}{d_{w1}}$$

Number of teeth z and pitch diameter d_w of the pulleys

The number of teeth z and the pitch diameter d_w of the pulleys are determined by means of pitch t of the chosen tooth profile.

$$z = \frac{\pi \cdot d_w}{t} \quad d_w = \frac{z \cdot t}{\pi} \text{ mm}$$

Numbers of teeth, pitch and outside diameters of pulleys are contained in Tables 7 to 13 on pages 12 to 15.

Arc of contact β

For two-pulley drives, the arc of contact β around the small pulley is calculated as follows:

$$\beta = 2 \cdot \arccos \left[\frac{t \cdot (z_g - z_k)}{2 \cdot \pi \cdot a} \right] \text{ } ^\circ(\text{Grad})$$

For multiple-pulley drives, the arc of contact β has to be calculated in accordance with the given geometry.

Belt speed v

Belt speed v is derived from speed n in r.p.m., number of teeth z and pitch t in mm or pitch diameter d_w .

$$v = \frac{n \cdot z \cdot t}{60 \cdot 10^3} = \frac{n \cdot d_w \cdot \pi}{60 \cdot 10^3} \text{ m/s}$$

Center distance a

Center distance is calculated as follows for circular path drives with two pulleys and where transmission ratio $i = 1$:

$$a = \frac{L_w - z \cdot t}{2} \text{ mm}$$

Where i does not equal 1, center distance a is approximated as below:

$$a \approx \frac{1}{4} \cdot \left[L_w - \frac{t}{2} \cdot (z_g + z_k) + \sqrt{\left[L_w - \frac{t}{2} \cdot (z_g + z_k) \right]^2 - 2 \cdot \left[\frac{t}{\pi} \cdot (z_g - z_k) \right]^2} \right] \text{ mm}$$

Pitch length L_w

For a two-pulley drive, pitch length L_w of the synchronous drive belt is approximated as below:

$$L_w \approx 2 \cdot a + \frac{t}{2} \cdot (z_g + z_k) + \frac{\left[\frac{t}{\pi} \cdot (z_g - z_k) \right]^2}{4 \cdot a} \text{ mm}$$

and calculated precisely as follows:

$$L_w = 2 \cdot a \cdot \sin \frac{\beta}{2} + \frac{t}{2} \cdot \left[z_g + z_k + \left(1 - \frac{\beta}{180} \right) \cdot (z_g - z_k) \right] \text{ mm}$$

For linear and multiple-pulley drives, pitch length L_w is determined in accordance with the given geometry.

Effective pull F_u , torque M , power P

The following equations are used to calculate effective pull F_u , torque M and power P :

$$\begin{aligned} F_u &= \frac{P \cdot 10^3}{v} = \frac{M \cdot 2 \cdot 10^3}{d_w} \text{ N} \\ &= \frac{P \cdot 9,55 \cdot 10^3}{n} = \frac{F_u \cdot d_w}{2 \cdot 10^3} \text{ Nm} \\ P &= \frac{M \cdot n}{9,55 \cdot 10^3} = \frac{F_u \cdot v}{10^3} \text{ kW} \end{aligned}$$

Calculation of synchronous belt drives

Drive calculation data

Belt width b

Belt width b is calculated from the effective pull F_U to be transmitted, the specific load on tooth flank $F_{U\text{ spez}}$ as well as the service factor c_0 and the teeth in mesh factor c_1 .

$$b_{\text{err}} = \frac{F_U \cdot c_0 \cdot 10}{F_{U\text{ spez}} \cdot c_1} \quad \text{mm}$$

Values for the specific load on tooth flank $F_{U\text{ spez}}$ can be taken from Figs. 6 to 7 on pages 24 and 26.

Once the belt standard width b has been determined, it is necessary to check the tension member load.

Permissible tension member loads F_{Zul} for synchronous drive belts with standard widths are contained in Tables 20 and 22 on pages 25 and 27. The following rule applies:

$$F_{Zul} \geq F_{T\text{ max}} \cdot c_0 \quad \text{N}$$

The next section explains how to determine the dynamic belt tension $F_{T\text{ max}}$.

Belt installation tension F_T

Tensioning of the belt is a decisive factor affecting the reliability, performance and life of a synchronous belt drive.

Calculation

For linear drives, installation tension is calculated as the belt tension. The following rule applies to the static belt tension F_T :

$$F_T \geq F_{U\text{ max}} \quad \text{N}$$

Maximum belt tension $F_{T\text{ max}}$ occurring in the dynamic state is derived from

$$F_{T\text{ max}} = F_T + F_{U\text{ max}} \quad \text{N}$$

With circular path drives, installation tension is usually given as shaft load F_V . The following equation applies:

$$F_V = F_U \cdot \sin \frac{\beta}{2} \quad \text{N}$$

Adjusting installation tension F_T via the takeup allowance

On linear drives, installation tension is adjusted via belt elongation. The takeup allowance a in mm is derived from the belt tension F_T , the belt dimensions L_w and b as well as the spring constants c_{spez} .

For linear drives as shown in Fig. 3 on page 18

$$\Delta a = \frac{F_T \cdot L_w}{2 \cdot c_{\text{spez}} \cdot b} \quad \text{mm}$$

For linear drives as shown in Fig. 4 on page 18

$$\Delta a = \frac{F_T \cdot L_w}{c_{\text{spez}} \cdot b} \quad \text{mm}$$

The values for the spring constants c_{spez} can be taken from Tables 21 and 23 on pages 25 and 27.

Adjusting installation tension via the frequency measurement method

Installation tension on linear drives can also be adjusted by measuring the natural frequency of a vibrating belt span. It must be remembered, however, that measurable vibrations are only obtainable from a free span length L_f up to a certain length.

See also our calculation examples.

$$f = \sqrt{\frac{F_T}{4 \cdot m \cdot L_f^2}}$$

Selecting the tooth profile

A suitable tooth profile is selected from Fig. 5 by locating the point at which the effective pull to be transmitted intersects with the possible belt width. The belt with the greatest power transmitting capacity should be selected. In borderline cases, it is recommended that the smaller profile is taken as a basis for drive design calculation.

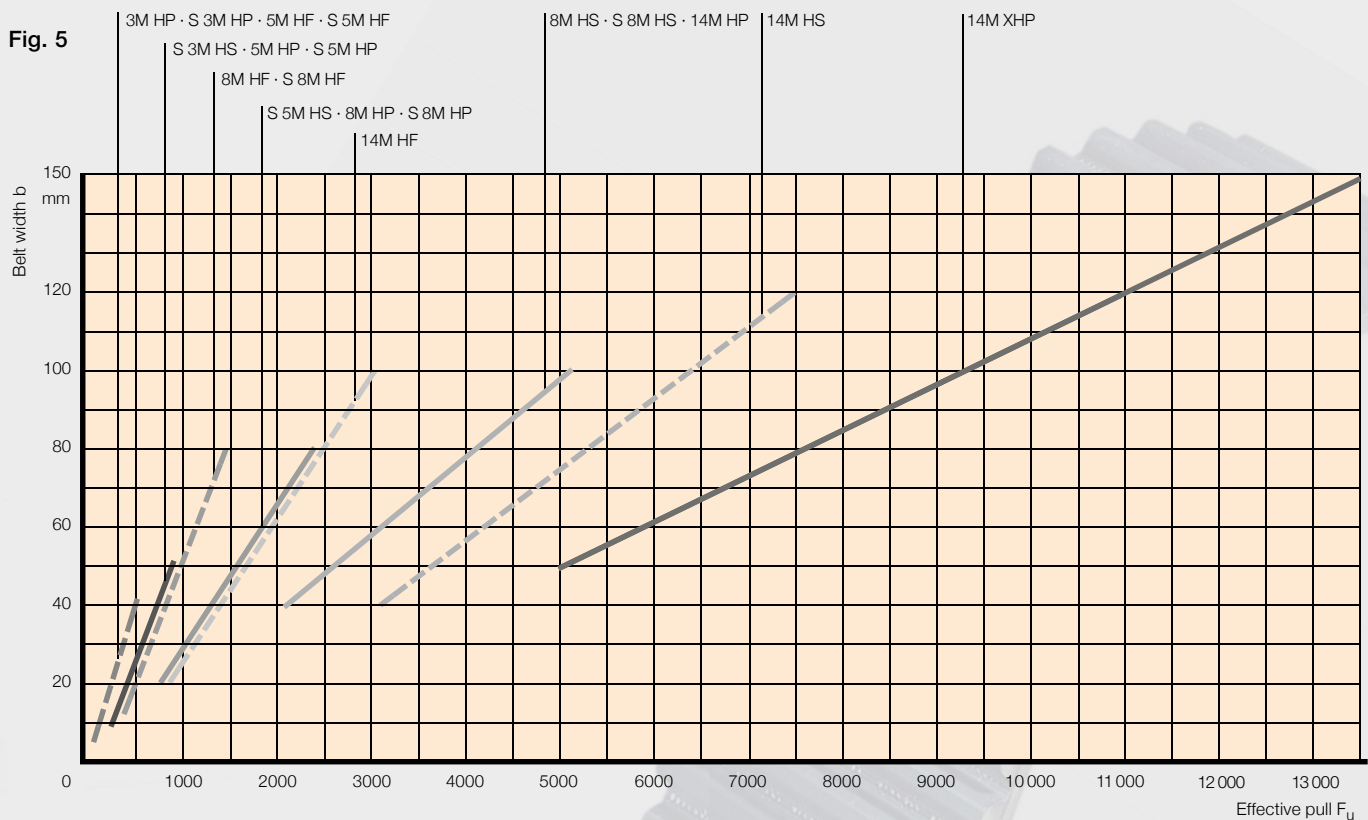

Diagram for selecting CONTI® SYNCHRODRIVE synchronous drive belts

Specific load on tooth flank $F_{U\text{ spez}}$, tension member load F_{Zul} , specific spring constant c_{spez}

The values required for the specific load on tooth flank, tension member load and specific spring constant in order to arrive at a precise drive design can be taken from the diagrams and tables on the following pages.

The specific load on tooth flank $F_{U\text{ spez}}$ can be taken from Figs. 6 and 7 after calculating speed n in r.p.m. from the

given belt speed v in m/s and the pulley diameter d_w in mm for the corresponding profile.

Tension member load F_{Zul} in N is given in Tables 20 and 22. Tables 21 and 23 show the specific spring constant c_{spez} in N/mm for calculating takeup allowance Δa .

Calculation of synchronous belt drives

Fig. 6

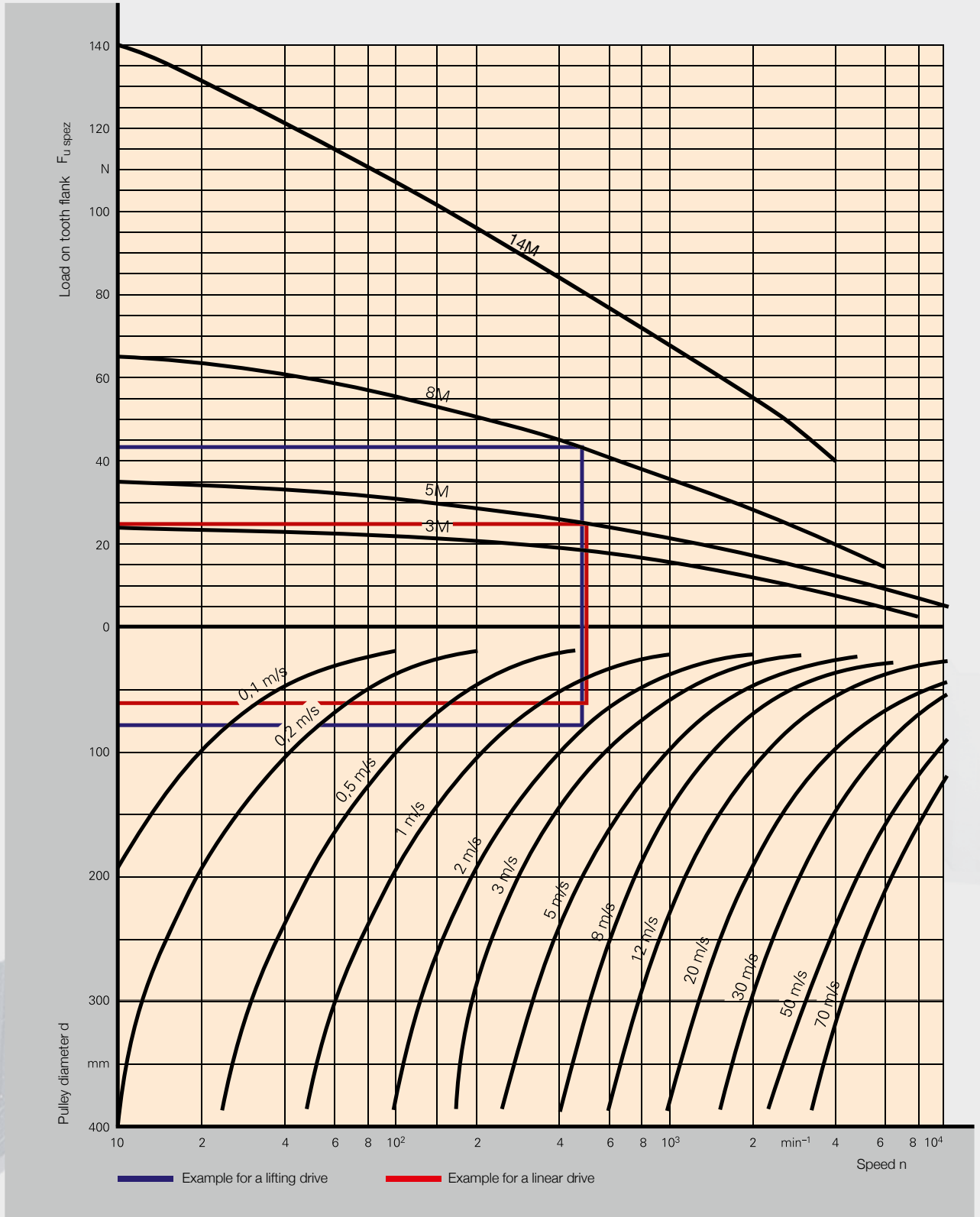

Specific load on tooth flank $F_{u\ spez}$ in N per 10 mm belt width and per meshing tooth for CONTI® SYNCHRODRIVE HTD synchronous drive belts 3M, 5M, 8M, 14M

Tab. 20 Allowable tension member load* F_{zul} in N at 0.4% elongation														
CONTI® SYNCHRODRIVE HTD synchronous drive belts – 3M, 5M, 8M, 14M														
Tooth profile Type/Version		3M HP	5M HF	HP	V-HF	8M HF	HP	HS	V-HF	14M HF	HP	HS	XHP	V-HF
Belt width b mm	5	150	150											
	10	300	300	650		650								
	15	450	450	975		975	1800	3150						
	20	600	600	1300	300	1300	2400	4200		2400				
	25	750	750	1625	375	1625	3000	5250	750	3000	5250			
	30	900	900	1950	450	1950	3600	6300	900	3600	6300	7500		1800
	40	1200	1200	2600	600	2600	4800	8400	1200	4800	8400	10000	19000	2400
	50	1500	1500	3250	750	3250	6000	10500	1500	6000	10500	12500	23800	3000
	55					3575	6600	11550	1650	6600	11550	13750	26100	3300
	85					5525	10200	17850	2550	10200	17850	21250	40400	5100
	100					6500	12000	21000	3000	12000	21000	25000	47600	6000
	115										24150	28750	54700	
	120										25200	30000	57100	
	150												71400	

* The breaking load equals about factor 4 in relation to the admissible load on the tension members.

Tab. 21 Specific spring constant c_{spez} in N/mm											
CONTI® SYNCHRODRIVE HTD synchronous drive belts – 3M, 5M, 8M, 14M											
Tooth profile Type/Version		3M HP	5M HF	HP	8M HF	HP	HS	14M HF	HP	HS	XHP
c_{spez}	N/mm	$7,5 \cdot 10^3$	$7,5 \cdot 10^3$	$20 \cdot 10^3$	$20 \cdot 10^3$	$35 \cdot 10^3$	$53 \cdot 10^3$	$35 \cdot 10^3$	$53 \cdot 10^3$	$63 \cdot 10^3$	$120 \cdot 10^3$

Calculation of synchronous belt drives

Fig. 7

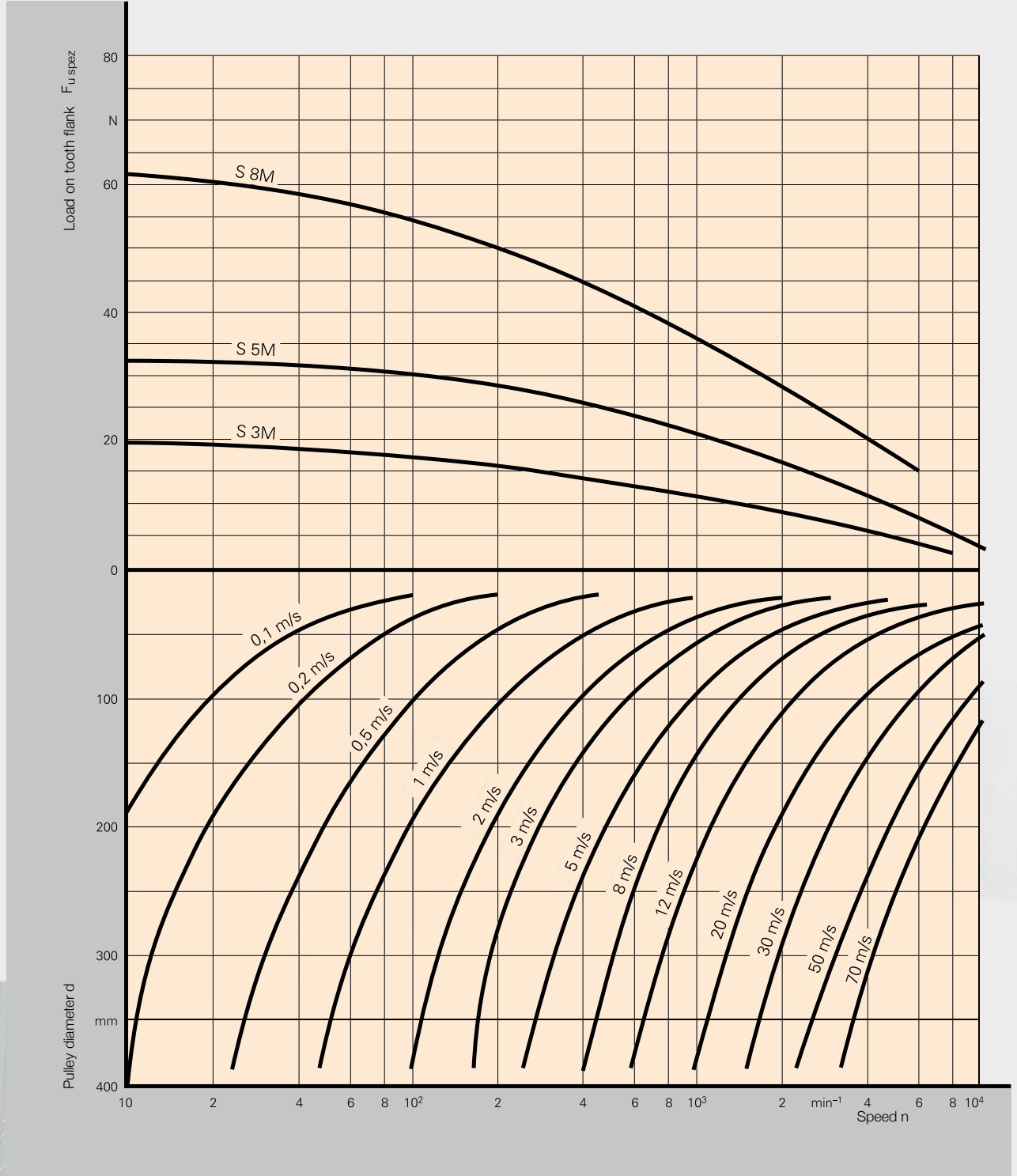

Specific load on tooth flank $F_{u\ spez}$ in N per 10 mm belt width and per meshing tooth for CONTI® SYNCHRODRIVE STD synchronous drive belts S 3M, S 5M, S 8M

Tab. 22 Allowable tension member load* F_{zul} in N at 0.4% elongation											
CONTI® SYNCHRODRIVE STD synchronous drive belts - S 3M, S 5M, S 8M											
Tooth profile Type/Version		S 3M HP	S 5M HF	HP	HS	V-HF	S 8M HF	HP	HS	V-HF	
Belt width b mm	5	150	150								
	10	300	300	650	1200		650				
	15	450	450	975	1800		975	1800	3150		
	20	600	600	1300	2400	300	1300	2400	4200		
	25	750	750	1625	3000	375	1625	3000	5250	750	
	30	900	900	1950	3600	450	1950	3600	6300	900	
	50	1500	1500	3250	6000	750	3250	6000	10500	1500	
	85						5525	10200	17850	2550	
	100						6500	12000	21000	3000	
	115								24150		
120								25200			

* The breaking load equals about factor 4 in relation to the admissible load on the tension members.

Tab. 23 Specific spring constant c_{spez} in N/mm								
CONTI® SYNCHRODRIVE STD synchronous drive belts - S 3M, S 5M, S 8M								
Tooth profile Type/Version		S 3M HP	S 5M HF	HP	HS	S 8M HF	HP	HS
c_{spez}	N/mm	$7,5 \cdot 10^3$	$7,5 \cdot 10^3$	$20 \cdot 10^3$	$35 \cdot 10^3$	$20 \cdot 10^3$	$35 \cdot 10^3$	$53 \cdot 10^3$

Calculation of synchronous belt drives

Examples of design procedure steps: Lifting drive

Fig. 8

Example

Determine the CONTI® SYNCHRODRIVE synchronous drive belt needed for a lifting drive with the following specification:

Pitch length of the belt	$L_w = 6000 \text{ mm}$
Pitch diameter of the pulleys	$d_w = 80 \text{ mm}$
Mass of the carriage	$m_s = 45 \text{ kg}$
Friction force	$F_R = 50 \text{ N}$
Travel at v_{const}	$s_c = 2,0 \text{ m}$
Travel speed	$v = 2 \text{ m/s}$
Acceleration	$a_b = 8,0 \text{ m/s}^2$
Braking deceleration	$a_v = 8,0 \text{ m/s}^2$

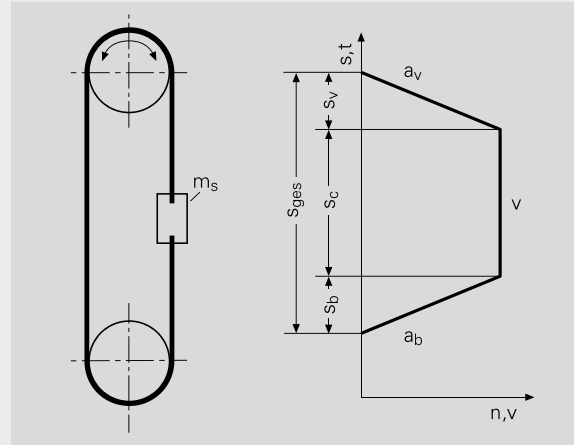

Lifting drive – principle and motion diagram

Calculate linear momentum

Acceleration distance

$$s_b = \frac{v^2}{2 \cdot a_b} \quad s_b = \frac{2^2}{2 \cdot 8} = 0,25 \text{ m}$$

Braking distance

$$s_v = \frac{v^2}{2 \cdot a_v} \quad s_v = \frac{2^2}{2 \cdot 8} = 0,25 \text{ m}$$

Total travel

$$s_{ges} = s_b + s_c + s_v \quad s_{ges} = 0,25 + 2,0 + 0,25 = 2,5 \text{ m}$$

Pulleys

Pitch diameter d_w from Table 9 on page 13

Selected: $d_w = 81.49 \text{ mm}$
 $z = 32$

Design-specific finished bore

$d_F = 40 \text{ mm}$

Mass of the pulleys according to manufacturer's specification

$m_{Sch} = 1,53 \text{ kg}$

Pulley designation

HTD Pulley
P 32 – 8M – 30

Select tooth profile

$$F_U = m_s \cdot a_b + m_s \cdot g$$

$$F_U = 45 \cdot 8 + 45 \cdot 9,81 = 801,5 \text{ N}$$

Select profile
Selected:

CONTI® SYNCHRODRIVE synchronous drive belt
profile 8M
width 30 mm
type M HP

Precisely determine the maximum effective pull to be transmitted

Mass of carriage m_s

$$m_s = 45 \text{ kg}$$

Mass of belt m_R

$$m_R = m_{\text{spez}} \cdot b \cdot L_w$$

Weight from Table 1 on page 7

$$m_R = 6,32 \cdot 10^{-3} \cdot 30 \cdot 6 = 1,14 \text{ kg}$$

Reduced mass of the pulleys

$$m_{\text{Sch red}} = \frac{m_{\text{Sch}}}{2} \cdot \left(1 + \frac{d_F^2}{d_a^2}\right)$$

$$m_{\text{Sch red}} = \frac{1,53}{2} \cdot \left(1 + \frac{40^2}{80,12^2}\right) = 0,96 \text{ kg}$$

Total mass

$$m_{\text{ges}} = m_s + m_R + M_{\text{Sch red}}$$

$$m_{\text{ges}} = 45 + 1,14 + 0,96 = 47,1 \text{ kg}$$

Maximum effective pull to be transmitted

$$F_{U \text{ max}} = m_{\text{ges}} \cdot a_b + m_s \cdot g + F_R$$

$$F_{U \text{ max}} = 47,1 \cdot 8 + 45 \cdot 9,81 + 50 = 868 \text{ N}$$

Calculation factors

Tooth in mesh factor

c_1 from page 20

$$c_1 = 12$$

Load factor for average fluctuation load

c_2 from Table 18 on page 20

$$c_2 = 1,7$$

Acceleration factor c_3

from Table 19 on page 20

$$c_3 = 0$$

Overall service factor

$$c_0 = c_2 + c_3$$

$$c_0 = 1,7 + 0 = 1,7$$

Determine belt width in accordance with allowable flank load

$$b_{\text{err}} = \frac{F_{U \text{ max}} \cdot c_0 \cdot 10}{F_{U \text{ spez}} \cdot c_1}$$

$F_{U \text{ spez}}$ from Table 6 on page 24

$$b_{\text{err}} = \frac{868 \cdot 1,7 \cdot 10}{43 \cdot 12} = 29 \text{ mm}$$

Requirement

$$b > b_{\text{err}}$$

Next greater belt width b

from Table 2 on page 7

$$\text{Selected: } b = 30 \text{ mm}$$

Calculation of synchronous belt drives

Belt installation tension

The following applies for linear drives:

$$F_T \geq F_{U \max}$$

Selected:
 $F_T = 900 \text{ N} > 868 \text{ N}$

Max. belt tension dynamic

$$F_{T \max} = F_T + F_{U \max}$$

$$F_{T \max} = 900 + 868 = 1768 \text{ N}$$

Takeup allowance for linear drives

$$\Delta a = \frac{F_T \cdot L_W \cdot 10^3}{2 \cdot c_{\text{spez}} \cdot b}$$

$$\Delta a = \frac{900 \cdot 6000}{2 \cdot 35 \cdot 30} = 2,6 \text{ mm}$$

c_{spez} from Table 21 on page 25

Alternatively it is possible to install the pretension via frequency measurement method. Therefore it is necessary to move the clamp end nearby (about 1 m) to the deflection point. This freely chosen span length can be used for calculation and measurements. See also page S. 22.

Free span length

Selected: $L_f = 1 \text{ m}$

Weight m per m length

$$m = m_{\text{spez}} \cdot b$$

m_{spez} from Table 1, Page 7

$$m = 6,32 \cdot 10^{-3} \cdot 30 = 0,19 \frac{\text{kg}}{\text{m}}$$

Belt tension frequency

$$f = \sqrt{\frac{F_T}{4 \cdot m \cdot L_f^2}}$$

$$f = \sqrt{\frac{900}{4 \cdot 0,19 \cdot 1^2}} = 34 \text{ Hz}$$

The belt has the right pretension when the measured frequency is the same as the calculated frequency.

Check allowable tension member load

F_{Zul} = from Table 20, Page 25

Requirement

$$F_{Zul} \geq F_{T \max} \cdot c_0$$

$$F_{Zul} = 3600 \text{ N}$$

$$3600 > 1768 \cdot 1,7$$

$$3600 > 3006$$

Requirement is fulfilled, i.e. the allowable tension member load is greater than the maximum belt tension taking the service factor into consideration.

Design choice:

CONTI® SYNCHRODRIVE HTD synchronous drive belt
 M 6 – 8M – 30 HP

Examples of design procedure steps: Linear drive

Fig. 9

Example

Determine the CONTI® SYNCHRODRIVE synchronous drive belt needed for a linear drive with the following specification:

Pitch length of the belt	$L_W = 8000 \text{ mm}$
Pitch diameter of the pulley	$d_W = 80 \text{ mm}$
Idler diameter	$d < 60 \text{ mm}$
Mass of carriage	$m_s = 30 \text{ kg}$
Coefficient of friction	$\mu = 0,6$
Travel time	$t_c = 3 \text{ s}$
Travel at v_{const}	$s_c = 5,0 \text{ m}$
Acceleration distance	$s_b = 0,5 \text{ m}$
Braking distance	$s_v = 1,5 \text{ m}$

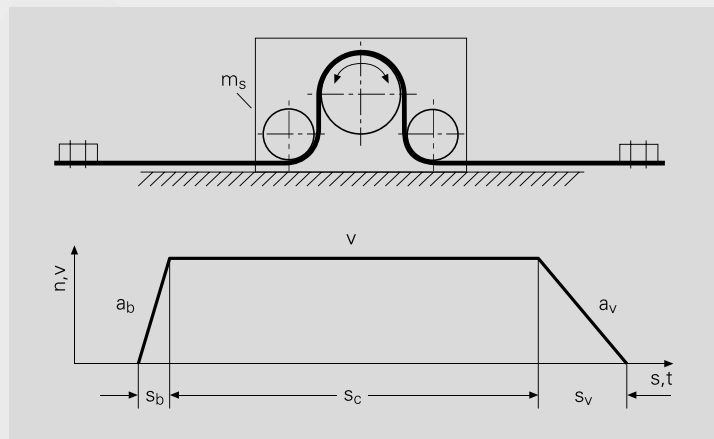

Linear drive – principle and motion diagram

Calculate acceleration and braking deceleration

Travel speed

$$v = \frac{s_c}{t_c} = \frac{5}{3} = 1,67 \text{ m/s}$$

Acceleration

$$a_b = \frac{v^2}{2 \cdot s_b} = \frac{1,67^2}{2 \cdot 0,5} = 2,79 \text{ m/s}^2$$

Braking deceleration

$$a_v = \frac{v^2}{2 \cdot s_v} = \frac{1,67^2}{2 \cdot 1,5} = 0,93 \text{ m/s}^2$$

Select tooth profile

Approximate calculation of
effective pull to be transmitted

$$F_U = m_s \cdot a_b + m_s \cdot g \cdot \mu$$

$$F_U = 30 \cdot 2,79 + 30 \cdot 9,81 \cdot 0,6 = 260 \text{ N}$$

Select profile from
Fig. 5,
page 23

Selected:
CONTI® SYNCHRODRIVE
synchronous drive belt, profile 5M
width 30 mm
type M HP

Calculation of synchronous belt drives

Pulleys

Pitch diameter d_w from Table 8, Page 12

Selected: $d_w = 60,48$ mm
 $z = 38$

Design-specific finished bore

$d_F = 30$ mm

Mass of the pulleys according to manufacturer's specification

$m_{Sch} = 0,47$ kg

Pulley designation

HTD Pulley P 38 – 5M – 15

Deflector idlers

Diameter

Selected: $d_a = 55$ mm

Finished bore

$d_F = 30$ mm

Mass of deflector idlers according to manufacturer's specification

$m_U = 0,43$ kg

Precisely determine the maximum effective pull to be transmitted

Reduced mass of the idlers

$$m_{U \text{ red}} = \frac{m_U}{2} \cdot \left(1 + \frac{d_F^2}{d^2}\right)$$

$$F_{U \text{ max}} = (m_s + m_{Sch} + 2 \cdot m_U) \cdot a_b + 2 \cdot m_{U \text{ red}} \cdot a_b + (m_s + m_{Sch} + 2 \cdot m_U) \cdot g \cdot \mu$$

$$m_{U \text{ red}} = \frac{0,43}{2} \cdot \left(1 + \frac{30^2}{55^2}\right) = 0,28 \text{ kg}$$

$$F_{U \text{ max}} = (30 + 0,47 + 2 \cdot 0,43) \cdot 2,79 + 2 \cdot 0,28 \cdot 2,79 + (30 + 0,47 + 2 \cdot 0,43) \cdot 9,81 \cdot 0,6 = 273 \text{ N}$$

Calculation factor

Tooth in mesh factor c_1 page 20

$c_1 = 12$

Load factor for low-fluctuation load c_2 from Table 18, Page 20

$c_2 = 1,4$

Acceleration factor c_3 from Table 19, Page 20

$c_3 = 0$

Overall service factor $c_0 = c_2 + c_3$

$c_0 = 1,4 + 0 = 1,4$

Determine belt width in accordance with allowable flank load

$$b_{err} = \frac{F_{u\ max} \cdot c_0 \cdot 10}{F_{u\ spez} \cdot c_1}$$

$F_{u\ spez}$ from Fig. 6, Page 24

Requirement $b > b_{err}$

Next greater belt width b from Table 2, Page 7

$$b_{err} = \frac{273 \cdot 1,4 \cdot 10}{25 \cdot 12} = 13\ \text{mm}$$

Selected: $b = 15\ \text{mm}$

Belt installation tension

The following applies for linear drives:

$$F_T \cong F_{u\ max}$$

Max. belt tension dynamic

$$F_{T\ max} = F_T + F_{u\ max}$$

Takeup allowance for linear drives

$$\Delta a = \frac{F_T \cdot L_w}{c_{spez} \cdot b}$$

c_{spez} from Table 21, Page 25

Alternatively it is possible to install the pretension via frequency measurement method. Therefore it is necessary to move the clamp end nearby (about 1 m) to the deflection point. This freely chosen span length can be used for calculation and measurements. See also page 22.

Free span length

Weight m per m length

$$m = m_{spez} \cdot b$$

m_{spez} from Table 1, Page 7

Selected:

$$F_T = 300\ \text{N} > 273\ \text{N}$$

$$F_{T\ max} = 300\ \text{N} + 273 = 573\ \text{N}$$

$$\Delta a = \frac{300 \cdot 8000\ \text{mm}}{20 \cdot 10^3 \cdot 15} = 8,0\ \text{mm}$$

Selected: $L_f = 1\ \text{m}$

$$m = 4,06 \cdot 10^{-3} \cdot 15 = 0,0609\ \frac{\text{kg}}{\text{m}}$$

Belt tension frequency

$$f = \sqrt{\frac{F_T}{4 \cdot m \cdot L_f^2}}$$

$$f = \sqrt{\frac{300}{4 \cdot 0,0609 \cdot 1^2}} = 35\ \text{Hz}$$

The belt has the correct pretension when the measured frequency is the same as the calculated frequency.

Check allowable tension member load

F_{zul} = from Table 20, Page 25

Requirement: $F_{zul} \geq F_{T\ max} \cdot c_0$

$$F_{zul} = 975\ \text{N}$$

$$975 > 573 \cdot 1,4$$

$$975 > 802$$

Requirement is fulfilled, i. e. the allowable tension member load is greater than the maximum belt tension taking the service factor into consideration.

Design choice

CONTI® SYNCHRODRIVE HTD synchronous drive belt
M8 – 5M – 15 HP

Index

A	
Acceleration factor	23
Available sizes	5, 6
Axial runout	17
B	
Belt back idlers	2
Belt elongation	26
Belt installation tension	2, 26, 36, 39
Belt adjustment	26
Belt calculation	26
Belt tension dynamic	25, 26
Belt tension static	26
Belt thickness	6
Belt widths	4 – 5 – 6, 25, 36
Benzene, resistance to	3
Bonding capability	2, 3
C	
Calculation	19 – 39
Calculation factors	36, 39
Center distance	24
Center distance factors	24
Clamp plates	18
Clamping screws	18
Codes – for belts	4
Codes – for pulleys	10
Constant speed	2
Construction of belts	4
Control cams	2
Control drives	2
D	
Definitions	20 – 22
Deflection idlers	38
Designation – of belts	4, 5
Designation – of pulleys	10, 11
Diameter of pulleys	12 – 16
Dimensions, belt	6
Dimensions - for clamp plates	18
DIN ISO 5296	6
Draft	17
Drive belts, synchronous	2
Drive pulleys	2
Drive system, positive	2, 4
Drives, circular path	23
Drives - 2 pulleys	24
E	
Effective pull	24, 25, 35, 38
Efficiency	3
Endless type V	2, 4
Examples of design procedures	34 – 39
F	
Fabric facing	3, 4
Flanged pulleys	10
Flexible version HF	4
Fluctuating load	23
G	
Gap clearance, minimized	10
Grease, resistance to	3
H	
HF – flexible version	4, 5
HP – reinforced version	4, 5
HTD synchronous drive belts	6 – 7
Hydrolysis, resistance to	3
I	
Idlers	11, 38
Idlers - minimum diameters	11
Inside idlers	11
Installation tension	2, 26, 36, 39
L	
Lengths	5, 6
Lifting drive	34
Linear distance	4, 5
Linear drive	3, 4, 37
Load factor	23
Load on tooth flank	25, 36, 39
Load on tooth flank - specific	27
Load, steady	23
Lubrication	3
M	
M – open-ended type	4
Maintenance	3
Minimum number of teeth	11
Minimum pitch diameter	11
Multiple-pulley drives	24
N	
Neutral pitch line	5
Number of teeth	10, 11, 24
Number of teeth - minimum	11
Number of teeth in mesh	22
O	
Oil resistance	3
Open-ended type M	2, 5
Operating conditions	22, 23
Outside diameter, pulleys	12–16, 17
Overall service factor	22, 25
Ozone resistance	3

P	
Parallelism	17
PAZ special version	4
Petrol, resistance to	3
Pitch circumference 1	0
Pitch diameter	10, 11, 23
Pitch diameter - minimum	11
Pitch length	5, 24
maximum	5
Pitch line	10
neutral	5
Pitch line distance	10
Polyurethane elastomer	2, 4
Positioning drives	2
Positive drive system	2, 4
Power	25
Profiles	5
Properties	2, 3
Pulley diameter, small	4
Pulleys	5, 10–17
– designation	10
– diameter	2, 12
– outside diameter	10, 11
– pitch diameter	11
– width	10
Pulley width	11
R	
Radial runout	17
Reinforced version HP	4, 5
Retensioning	3
Reversing drives	2
S	
Safety factors	22
Selection of tooth profile	27, 35, 38
Service factor	22, 25
Shaft load	26
Small pulley diameter	4
Special version PAZ	4
Specifications of belt	6
Speed of belt	24
Spring constant	26, 27
Stability, dynamic	2
Standard lengths	6
Standard types	6
Standard widths	2, 6 – 7, 25
STD synchronous drive belts	6 – 7
Steady load	23
Steel-cord tension member	2, 3, 4, 5
Step-up transmission	23
Symbols	20 – 22
Synchronous belt drives calculation	19 – 39
Synchronous conveyor systems	3
Synchronous transmission	2

T	
Takeup allowance	26, 27
Teeth in mesh factor	22, 25
Temperature resistance	3
Tensile strength	4
Tension member	5
Tension member load	25, 27
Tension member load - permissible	36, 39
Tolerances	
– for belt lengths	7
– for belt thicknesses	7
– for belt widths	7
– for pulleys	17
Tooth grip	10
Tooth height	6
Tooth pitch	4, 6, 10
Tooth profiles	2, 6
Tooth profiles - selection	27, 35
Torque	24
Transmission ratio	23
Transport cams	2
Transport devices	2, 3
Trapezoidal belts	5 – 6
Types of belt	2, 3, 4, 5
- endless	2, 4, 5
- flexible	4, 5
- open-ended	2, 4, 5
- reinforced	3, 4
- special	3, 4
U	
Units	20 – 22
UV resistance	3
V	
V – endless type	4
W	
Wear-resistant	3
Weight of belt	7
Width designation of belts	5
Width designation of pulleys	10
Widths - pulleys	10
Widths - standard	5, 6, 7, 25
Widths - synchronous drive belts	6 – 7, 25

Mulco belt-pilot

Your direct road to perfect design solutions

Mulco belt-pilot – online support at www.mulco.net

Let others talk about being close to the customer, we as the market leading provider of polyurethane timing belts actually live by the idea. Mulco-Europe EWIV's secret of success has always been largely due to advising our customers before they enter the design stage. Mulco belt-pilot is taking our customer dedication a critical step further ahead. Our interactive Internet service offering enables you to calculate your personal design solutions online. Whatever field of technology you are interested in - power transmission, linear, transport or components - start Mulco belt-pilot at www.mulco.net for 24/7 access to the actual product information, CAD downloads and calculations you need.

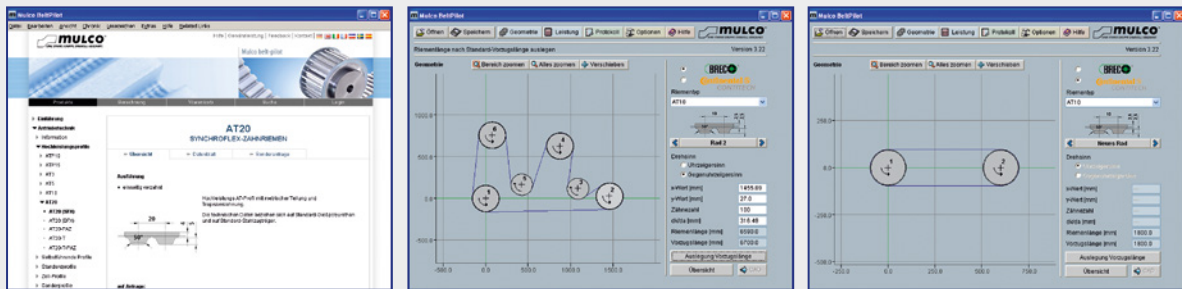

Mulco belt-pilot

Many benefits.

- ▶ Interactive service offering with video-based e-learning option
- ▶ Extensive product databases
- ▶ Free use of CAD downloads
- ▶ Import the CAD drawings into your CAD system
- ▶ Calculate timing belts, pulleys and components
- ▶ Email inquiries supported



Polyurethane timing belt welder

Welds what belongs together

The portable TSG 5 welder – ready for a quick change

Even top-quality products will eventually wear out. The same applies to polyurethane timing belts which, from time to time, need to be replaced. We designed the portable TSG welder to assist you in replacing drive units that take a lot of mounting effort and are difficult to access due to upstream machine components. The portable TSG welder is easy to operate and allows you to weld polyurethane timing belts onsite, immediately in or at the machine. The TSG 5 welding unit is available in two versions: for belt widths up to 50 mm and for belt widths up to 100 mm.

One welder, many benefits

- Suitable for all timing belt profiles
- Short machine downtimes
- Easy to operate
- Flexible through long power cords
- Welds and cools down in as little as about 30 minutes
- Air-cooled, no water supply required
- Powerful heater output

Standard package

- Welder with belt-specific, replaceable weld face
- Control unit for automatic welding and cooling down
- Control unit and welder connect by metal-reinforced cable
- Transport case with tools

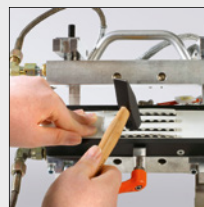
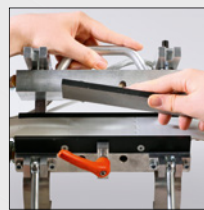

Technical data TSG 5 - 50

Operating voltage: 230 V/50 Hz

Power consumption: 1.2 kW

Welder dimensions:

W 240 mm x H 220 mm x D 170 mm

Welder weight: approx. 7.5 kg*

Control unit dimensions:

Typ IV / PPuls

W 100 mm x H 190 mm x D 45 mm

Control unit weight: approx. 1.0 kg

Carrying case weight: approx. 6.0 kg

Technical data TSG 5 - 100

Operating voltage: 230 V/50 Hz

Power consumption: 2 kW

Welder dimensions:

W 240 mm x H 220 mm x D 220 mm

Welder weight: approx. 9.5 kg*

Control unit dimensions:

Typ IV / PPuls

W 100 mm x H 190 mm x D 45 mm

Control unit weight: approx. 1.0 kg

Carrying case weight: approx. 6.0 kg

* including connecting leads



Special accessories

- Hydraulic punch
- Weld jigs for all standard belt profiles
- Punch box
- All units available separately

List of Catalogues

All our information at a glance

Polyurethane Timing Belts

BRECO®, BRECOFLEX® timing belts
BRECO®, BRECOFLEX® – Processing of timing belts
BRECO®, BRECOFLEX® flat belts
BRECO® ATN-system
BRECOprotect® – Timing Belts
BRECObasic® – Timing Belts
BRECOMove, BRECOFLEXmove - Timing Belts

CONTI® SYNCHROFLEX Polyurethane Timing Belts. Overall catalog
CONTI® SYNCHROCHAIN CARBON Heavy-Duty Timing Belts
CONTI® SYNCHRODRIVE Polyurethane Synchronous Drive Belts
CONTI® SYNCHRODRIVE N10 Nubbed Belt

Pulleys and Accessories

PULLEYS & COMPONENTS for polyurethane timing belt drives
Portable TSG 5 welder for polyurethane timing belts

**All product information
can be requested from
your Mulco Partner.**

**New information material
available for download at
www.mulco.net**



MULCO® is a registered trademark of
Wilhelm Herm. Müller GmbH & Co. KG,
Heinrich-Nordhoff-Ring 14, 30826 Garbsen, Germany.

© 2021 Mulco-Europe EWIV. All rights reserved.
Reproduction of the entirety of text or parts prohibited.



Sales partners Germany



Hilger u. Kern GmbH
Industrietechnik
Käfertaler Straße 253
68167 Mannheim
Phone: +49 621 3705-0
Fax: +49 621 3705-403
e-mail: antriebstechnik@hilger-kern.de
www.hilger-kern.com



Anton Klocke Antriebstechnik GmbH
Senner Straße 151
33659 Bielefeld
Phone: + 49 521 95005-01
Fax: + 49 521 95005-11
e-mail: info@klocke-antrieb.de
www.klocke-antrieb.de

Sales partner France



BINDER MAGNETIC
1 allée des Barbanniers
92632 Gennevilliers Cedex
France
Phone: +33 1 46 13 80 80
e-mail: info@binder-magnetic.fr
www.binder-magnetic.com

Sales partner Austria



Haberkorn GmbH
Modecenterstraße 7
1030 Wien
Austria
Phone: +43 1 74074-0
Fax: +43 1 74074-99
e-mail: antriebselemente@haberkorn.com
www.haberkorn.com



Wilhelm Herm. Müller GmbH & Co. KG
Heinrich-Nordhoff-Ring 14
30826 Garbsen
Phone: +49 5131 4522-0
Fax: +49 5131 4522-110
e-mail: info@whm.net
www.whm.net



REIFF Technische Produkte GmbH
Tübinger Straße 2-6
72762 Reutlingen
Phone: +49 7121 323-3130
Fax: +49 7121 323-3460
e-mail: zahnriemen@reiff-gruppe.de
www.reiff-tp.de

Sales partner Sweden



Aratron AB
Solna Strandväg 78, 4tr
171 54 Solna
Sweden
Phone: +46 8 404 16 00
e-mail: info@aratron.se
www.aratron.se

Sales partner United Kingdom



Transmission Developments Co. (GB) Ltd
Dawkins Road
Poole, Dorset, BH15 4HF
United Kingdom
Phone: +44 1202 675555
Fax: +44 1202 677466
e-mail: info@transdev.co.uk
www.transdev.co.uk



Roth GmbH & Co. KG
Andernacher Straße 14
90411 Nürnberg
Phone: +49 911 99521-0
Fax: +49 911 99521-70
e-mail: info@roth-ing.de
Chat: by MS-Teams
www.roth-ing.de



Walter Rothermundt GmbH & Co. KG
Mülforter Zeug 12
41199 Mönchengladbach
Phone: +49 2166 45133-0
e-mail: info@rothermundt.de
www.rothermundt.de

Sales partner Spain



DINAMICA Drive Solutions, S.A.
Ctra. N. II, km 592,6
08740 S. Andreu de la Barca
Spain
Phone: +34 93 6533-500
e-mail: dinamica@dinamica.net
www.dinamica.net

